

DIN 69871/A, CORPO MANDRINO BILANCIATO, PER FRESE (WELDON)
SECONDO NORMA DIN 1835 B E DIN 6535 HB. FORNITO CON VITE DI...

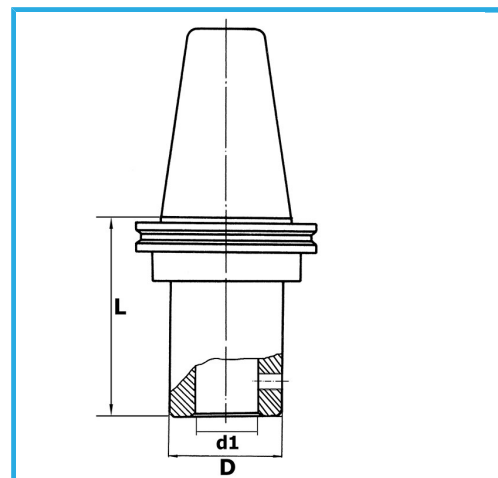

€133,00



ISO	50
d1 - h6	10 mm
D	35 mm
L	70 mm
Peso lordo	3,00 kg
Codice EAN	8012667193096



Scatola



Rettificato

18Ni
CrMo5