

DIN 69871/A, BALANCED CHUCK BODY, FOR MILLING CUTTERS (WELDON) ACCORDING TO DIN 1835 B AND DIN 6535 HB. SUPPLIED WITH TIGHTENING..

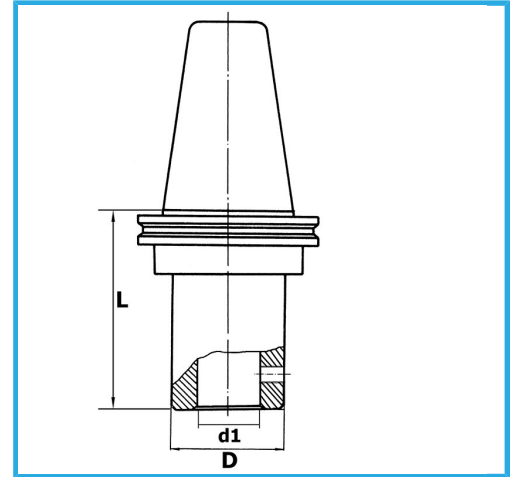

ISO	40
d1 - h6	12 mm
D	42 mm
L	60 mm
Gross weight	1,24 kg
EAN Code	8012667195519



Box



Grounded

18Ni
CrMo5

-