

DIN 69871/A, AUSGEWUCHTETES SPANNFUTTERGEHÄUSE, FÜR
FRÄSER (WELDON) NACH DIN 1835 B UND DIN 6535 HB. LIEFERUNG...

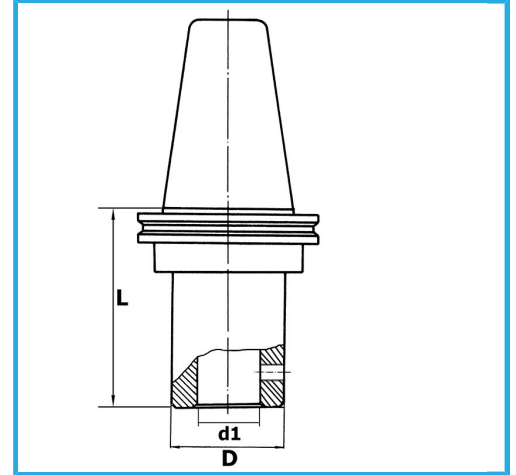

ISO	50
d1 - h6	12 mm
D	42 mm
L	75 mm
Bruttogewicht	3,00 kg
EAN-Code	8012667193126



Box



Korrigiert



18Ni
CrMo5

-