

DIN 69871/A, CON CUERPO EQUILIBRADO, PARA FRESAS (WELDON)
SEGÚN DIN 1835 B Y DIN 6535 HB. SE SUMINISTRA CON TORNILLO
DE...

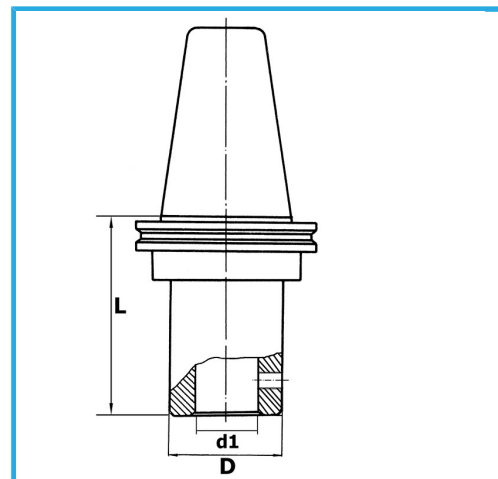

€133,00



ISO	50
d1 - h6	16 mm
D	48 mm
L	80 mm
Peso bruto	3,38 kg
Codigo de barras	8012667193171



Caja



Rectificado

18Ni
CrMo5

-