

DIN 69871/A, AUSGEWUCHTETES SPANNFUTTERGEHÄUSE, FÜR
FRÄSER (WELDON) NACH DIN 1835 B UND DIN 6535 HB. LIEFERUNG...

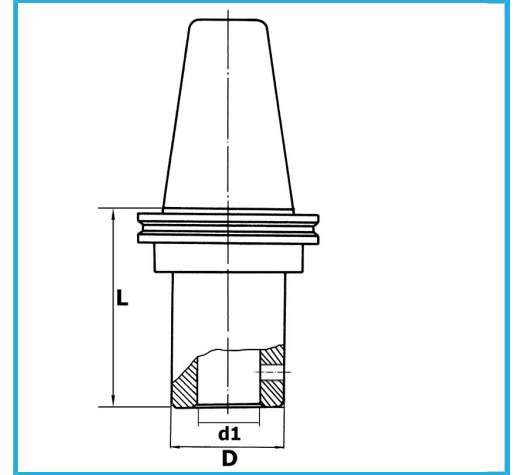

ISO	40
d1 - h6	18 mm
D	48 mm
L	70 mm
Bruttogewicht	1,36 kg
EAN-Code	8012667195540



Box



Korrigiert



18Ni
CrMo5

-