

DIN 69871/A, CORPO MANDRINO BILANCIATO, PER FRESE (WELDON)  
SECONDO NORMA DIN 1835 B E DIN 6535 HB. FORNITO CON VITE DI...

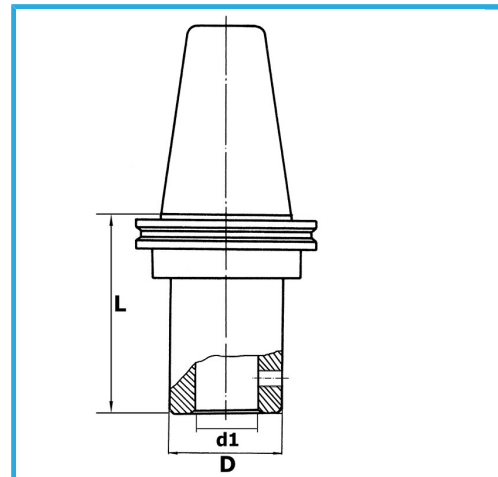

€96,50



ISO	40
d1 - h6	18 mm
D	48 mm
L	70 mm
Peso lordo	1,36 kg
Codice EAN	8012667195540



Scatola



Rettificato



18Ni  
CrMo5