

DIN 69871/A, CORPO MANDRINO BILANCIATO, PER FRESE (WELDON)
SECONDO NORMA DIN 1835 B E DIN 6535 HB. FORNITO CON VITE DI...

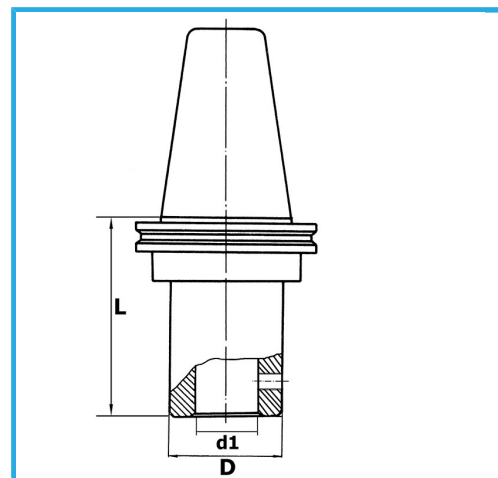

€140,00



ISO	50
d1 - h6	25 mm
D	65 mm
L	100 mm
Peso lordo	3,87 kg
Codice EAN	8012667193218



Scatola



Rettificato



18Ni
CrMo5