

DIN 69871/A, AUSGEWUCHTETES SPANNFUTTERGEHÄUSE, FÜR  
FRÄSER (WELDON) NACH DIN 1835 B UND DIN 6535 HB. LIEFERUNG...

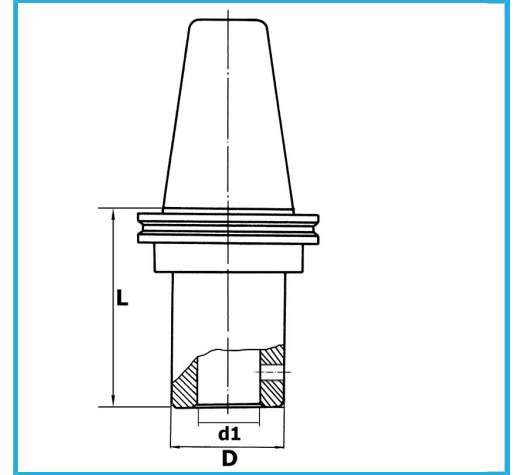

ISO	40
d1 - h6	32 mm
D	72 mm
L	100 mm
Bruttogewicht	2,73 kg
EAN-Code	8012667195854



Box



Korrigiert



18Ni  
CrMo5

-