

DIN 69871/A, CORPO MANDRINO BILANCIATO, PER FRESE (WELDON)
SECONDO NORMA DIN 1835 B E DIN 6535 HB. FORNITO CON VITE DI...

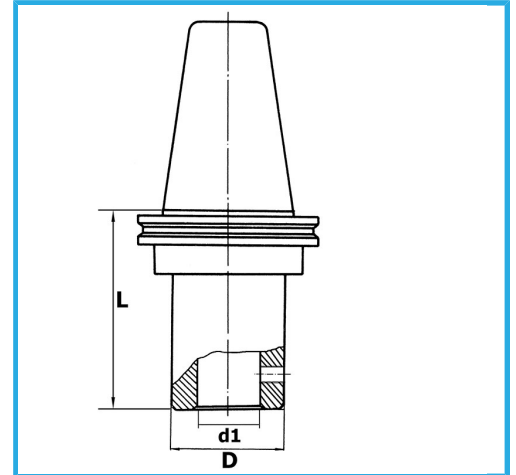

€153,00



ISO	50
d1 - h6	40 mm
D	80 mm
L	120 mm
Peso lordo	5,86 kg
Codice EAN	8012667187613



Scatola



Rettificato

18Ni
CrMo5