

DIN 69871/A, AUSGEWUCHTETES SPANNFUTTERGEHÄUSE, FÜR
ZYLINDRISCHE SCHAFTFRÄSER NACH DIN 481, FÜR FRÄSER...

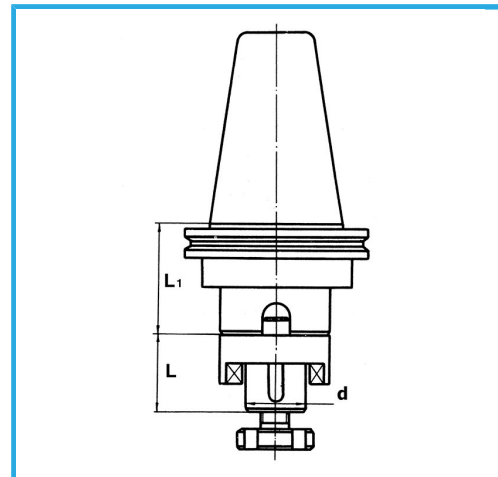

ISO	50
d-h6	40 mm
L	41 mm
L1	40 mm
Auswuchtdrehzahl rpm	12000
Bruttogewicht	4,12 kg
EAN-Code	8012667008161



Box

18Ni
CrMo5



Korrigiert