

DIN 69871/A, AUSGEWUCHTETES SPANNFUTTERGEHÄUSE, MIT
ABSAUGSCHLITZ FÜR WERKZEUGE. AUSWUCHTDREHZAHL 12.000
RPM.

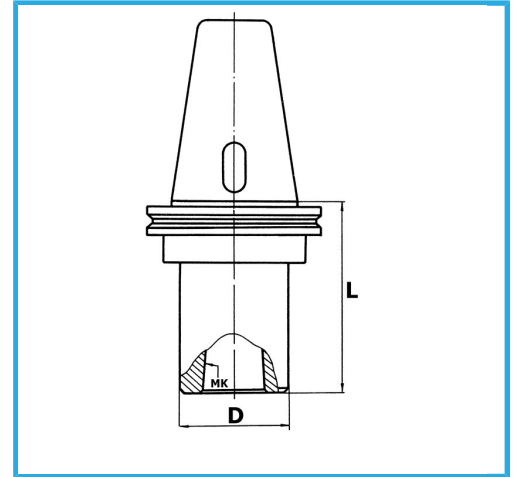

ISO	40
CM	1
D	25 mm
L	45 mm
Bruttogewicht	0,97 kg
EAN-Code	8012667007775



Box



Korrigiert



18Ni
CrMo5

-