

DIN 69871/A, CON CUERPO EQUILIBRADO, CON RANURA DE EXTRACCIÓN PARA HERRAMIENTAS. EQUILIBRADO 12.000 RPM.

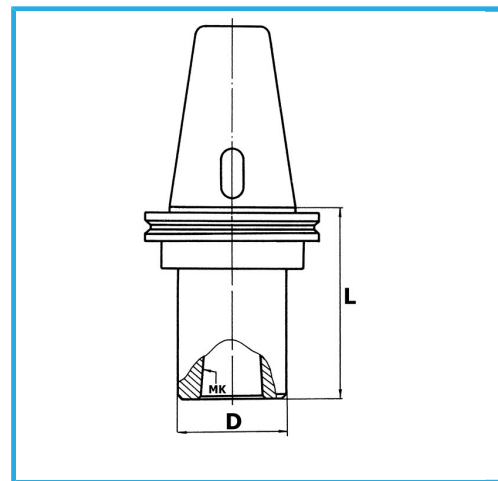

€105,00



ISO	40
CM	1
D	25 mm
L	45 mm
Peso bruto	0,97 kg
Codigo de barras	8012667007775



Caja



Rectificado

18Ni  
CrMo5