

DIN 69871/A, AUSGEWUCHTETES SPANNFUTTERGEHÄUSE, MIT
ABSAUGSCHLITZ FÜR WERKZEUGE. AUSWUCHTDREHZAHL 12.000
RPM.

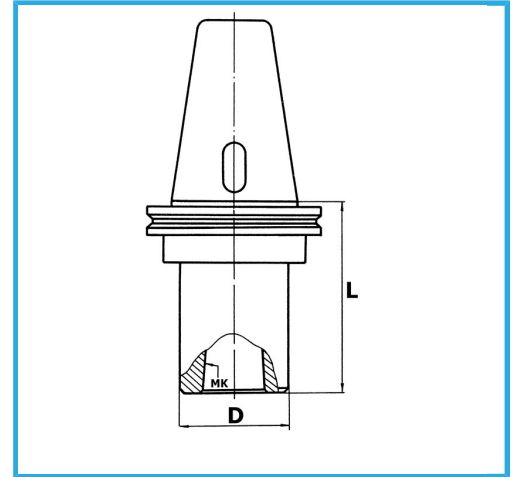

ISO	40
CM	2
D	32 mm
L	60 mm
Bruttogewicht	1,09 kg
EAN-Code	8012667007782



Box



Korrigiert



18Ni
CrMo5

-