

DIN 69871/A, CON CUERPO EQUILIBRADO, CON RANURA DE EXTRACCIÓN PARA HERRAMIENTAS. EQUILIBRADO 12.000 RPM.

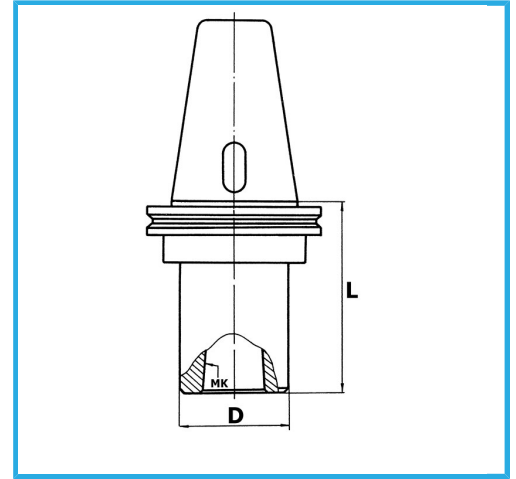

€105,00



ISO	40
CM	2
D	32 mm
L	60 mm
Peso bruto	1,09 kg
Codigo de barras	8012667007782



Caja



Rectificado



18Ni
CrMo5

-