

DIN 69871/A, CORPO MANDRINO BILANCIATO, CON ASOLA DI ESTRAZIONE PER UTENSILI. EQUILIBRATURA 12.000 RPM.

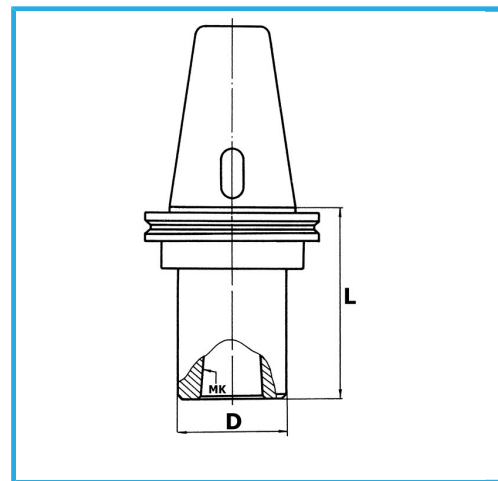

€105,00



ISO	40
CM	2
D	32 mm
L	60 mm
Peso lordo	1,09 kg
Codice EAN	8012667007782



Scatola



Rettificato

18Ni
CrMo5