

DIN 69871/A, CORPO MANDRINO BILANCIATO, CON ASOLA DI ESTRAZIONE PER UTENSILI. EQUILIBRATURA 12.000 RPM.

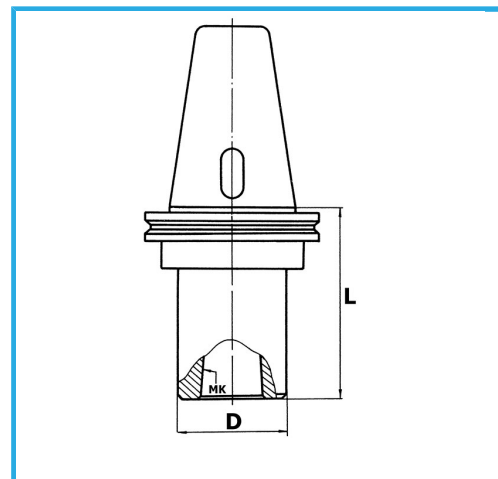

€211,00



ISO	50
CM	2
D	32 mm
L	40 mm
Peso lordo	2,63 kg
Codice EAN	8012667007867



Scatola



Rettificato

18Ni  
CrMo5