

DIN 69871/A, AUSGEWUCHTETES SPANNFUTTERGEHÄUSE, MIT
ABSAUGSCHLITZ FÜR WERKZEUGE. AUSWUCHTDREHZAHL 12.000
RPM.

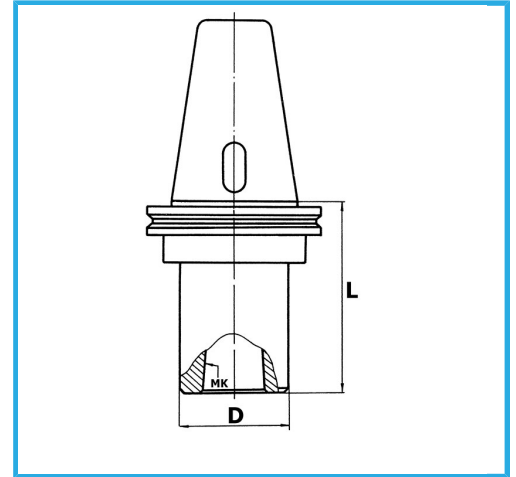

ISO	40
CM	3
D	40 mm
L	75 mm
Bruttogewicht	1,16 kg
EAN-Code	8012667007799



Box



Korrigiert



18Ni
CrMo5

-