

DIN 69871/A, CON CUERPO EQUILIBRADO, CON RANURA DE EXTRACCIÓN PARA HERRAMIENTAS. EQUILIBRADO 12.000 RPM.

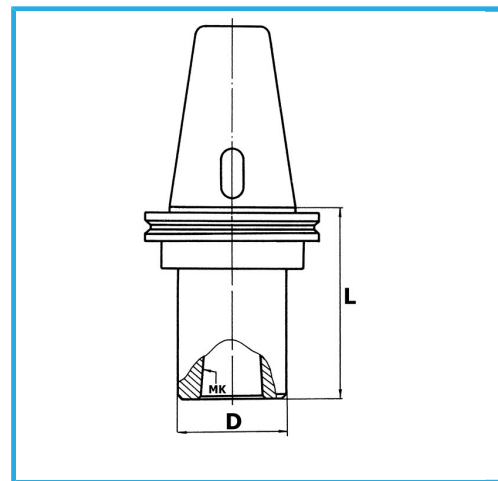

€105,00



ISO	40
CM	3
D	40 mm
L	75 mm
Peso bruto	1,16 kg
Codigo de barras	8012667007799



Caja



Rectificado

18Ni  
CrMo5