

DIN 69871/A, CORPO MANDRINO BILANCIATO, CON ASOLA DI ESTRAZIONE PER UTENSILI. EQUILIBRATURA 12.000 RPM.

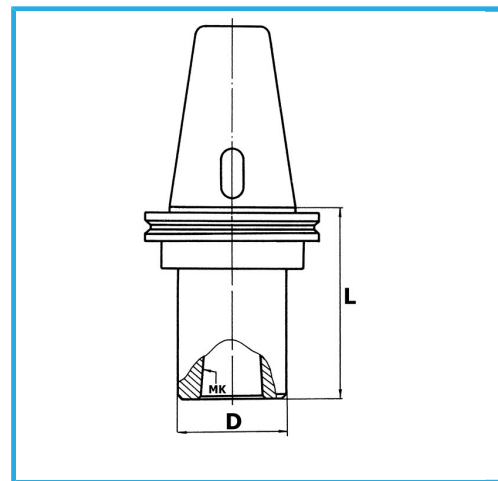

€105,00



ISO	40
CM	3
D	40 mm
L	75 mm
Peso lordo	1,16 kg
Codice EAN	8012667007799



Scatola



Rettificato

18Ni
CrMo5