

DIN 69871/A, AUSGEWUCHTETES SPANNFUTTERGEHÄUSE, MIT
ABSAUGSCHLITZ FÜR WERKZEUGE. AUSWUCHTDREHZAHL 12.000
RPM.

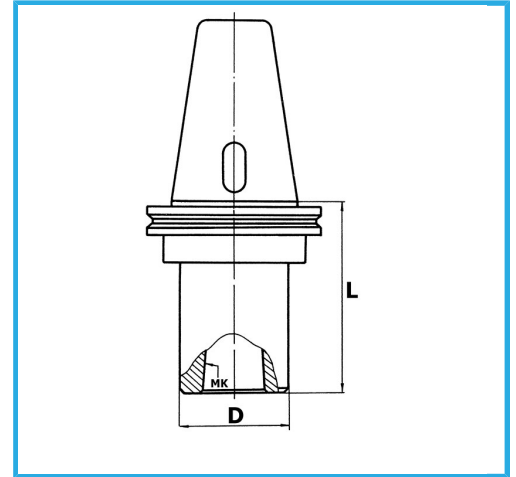

ISO	50
CM	3
D	40 mm
L	50 mm
Bruttogewicht	2,85 kg
EAN-Code	8012667007874



Box



Korrigiert

18Ni
CrMo5

-