

DIN 69871/A, AUSGEWUCHTETES SPANNFUTTERGEHÄUSE, MIT
ABSAUGSCHLITZ FÜR WERKZEUGE. AUSWUCHTDREHZAHL 12.000
RPM.

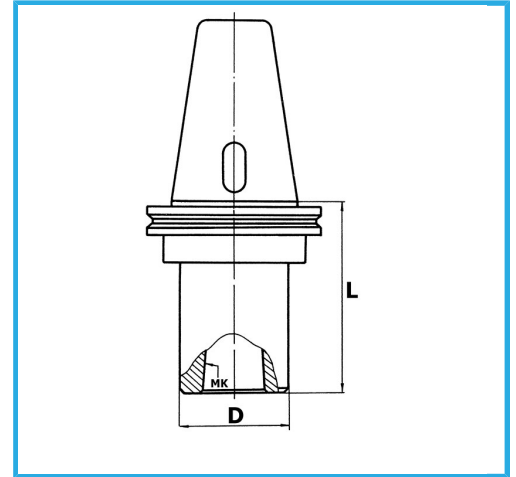

ISO	40
CM	4
D	50 mm
L	98 mm
Bruttogewicht	1,33 kg
EAN-Code	8012667007805



Box



Korrigiert



18Ni
CrMo5

-