

DIN 69871/A, CORPO MANDRINO BILANCIATO, CON ASOLA DI ESTRAZIONE PER UTENSILI. EQUILIBRATURA 12.000 RPM.

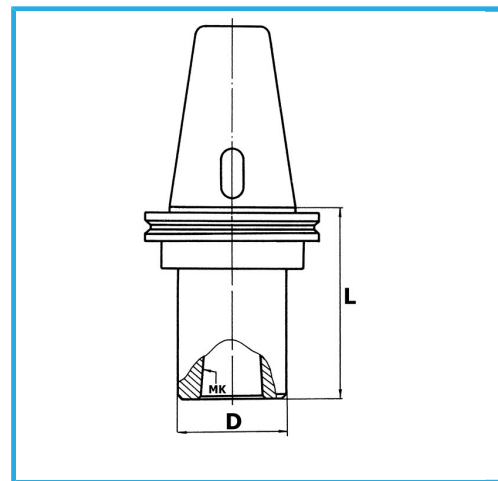

€211,00



ISO	50
CM	4
D	48 mm
L	95 mm
Peso lordo	3,00 kg
Codice EAN	8012667007881



Scatola



Rettificato

18Ni
CrMo5