

DIN 69871/A, AUSGEWUCHTETES SPANNFUTTERGEHÄUSE, MIT
ABSAUGSCHLITZ FÜR WERKZEUGE. AUSWUCHTDREHZAHL 12.000
RPM.

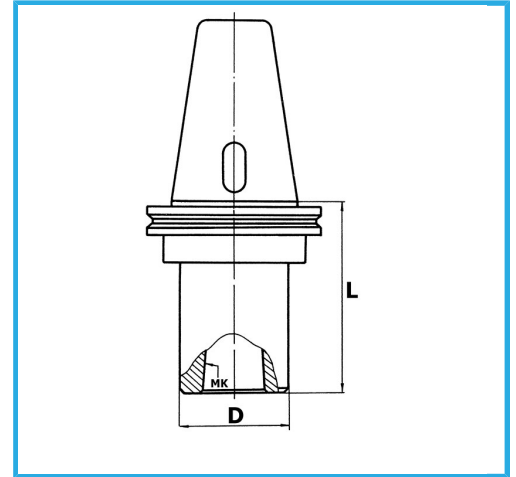

ISO	50
CM	5
D	63 mm
L	110 mm
Bruttogewicht	3,29 kg
EAN-Code	8012667007898



Box



Korrigiert



18Ni
CrMo5

-