

DIN 69871/A, AUSGEWUCHTETES SPANNFUTTERGEHÄUSE.
AUSWUCHTDREHZAHL 12.000 RPM.

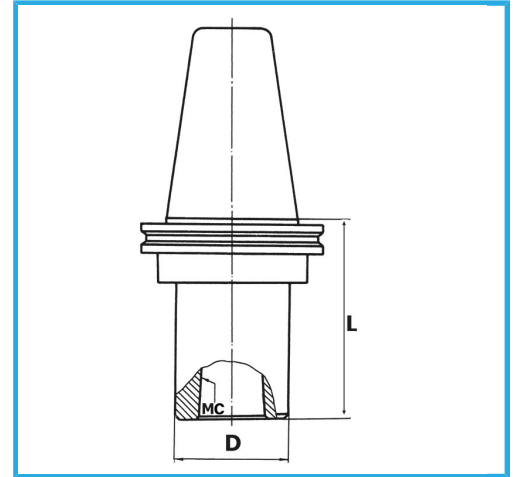

ISO	40
CM	1
D	25 mm
L	45 mm
Bruttogewicht	0,99 kg
EAN-Code	8012667007904



Box



Korrigiert

18Ni
CrMo5

-