

DIN 69871/A, BALANCED CHUCK BODY. BALANCING 12.000 RPM.

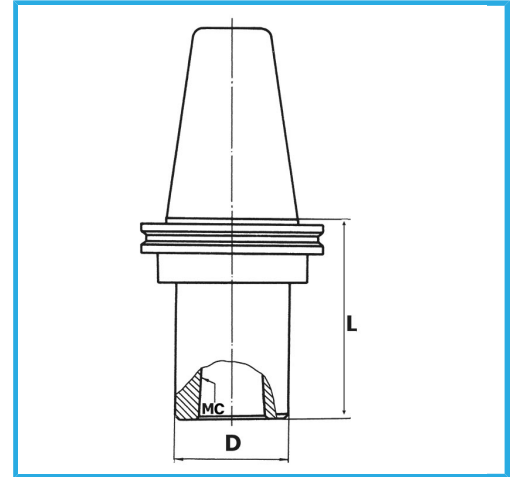

ISO	40
MT	1
D	25 mm
L	45 mm
Gross weight	0,99 kg
EAN Code	8012667007904



Box



Grounded



18Ni
CrMo5

-