

DIN 69871/A, AUSGEWUCHTETES SPANNFUTTERGEHÄUSE.
AUSWUCHTDREHZAHL 12.000 RPM.

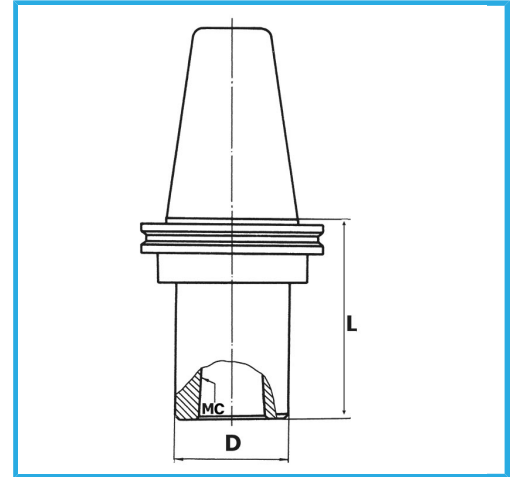

ISO	40
CM	2
D	32 mm
L	60 mm
Bruttogewicht	1,23 kg
EAN-Code	8012667007911



Box



Korrigiert

18Ni
CrMo5

-