

DIN 69871/A, CON CUERPO EQUILIBRADO. EQUILIBRADO 12.000 RPM.

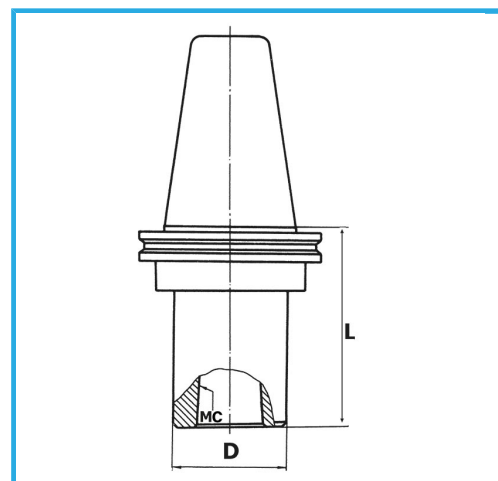

€133,00



ISO	40
CM	2
D	32 mm
L	60 mm
Peso bruto	1,23 kg
Codigo de barras	8012667007911



Caja



Rectificado

18Ni
CrMo5