

DIN 69871/A, CORPO MANDRINO BILANCIATO. EQUILIBRATURA 12.000 RPM.

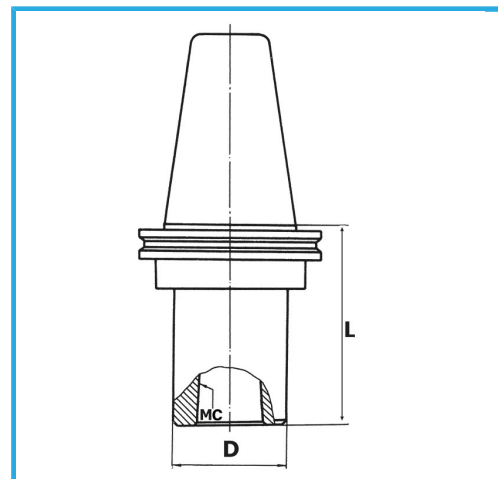

€133,00



ISO	40
CM	2
D	32 mm
L	60 mm
Peso lordo	1,23 kg
Codice EAN	8012667007911



Scatola



Rettificato

18Ni  
CrMo5