

DIN 69871/A, AUSGEWUCHTETES SPANNFUTTERGEHÄUSE.
AUSWUCHTDREHZAHL 12.000 RPM.

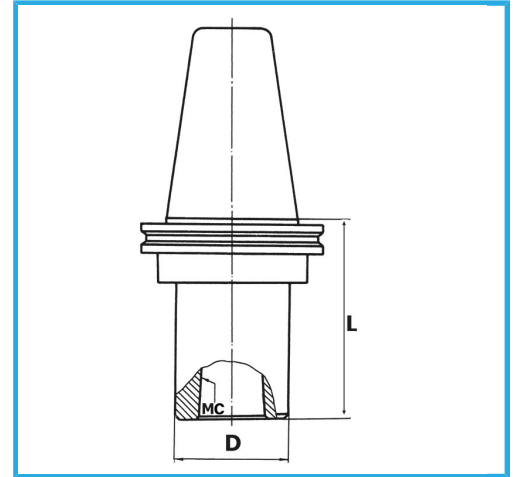

ISO	50
CM	2
D	32 mm
L	40 mm
Bruttogewicht	2,77 kg
EAN-Code	8012667007997



Box



Korrigiert



18Ni
CrMo5

-