

DIN 69871/A, AUSGEWUCHTETES SPANNFUTTERGEHÄUSE.
AUSWUCHTDREHZAHL 12.000 RPM.

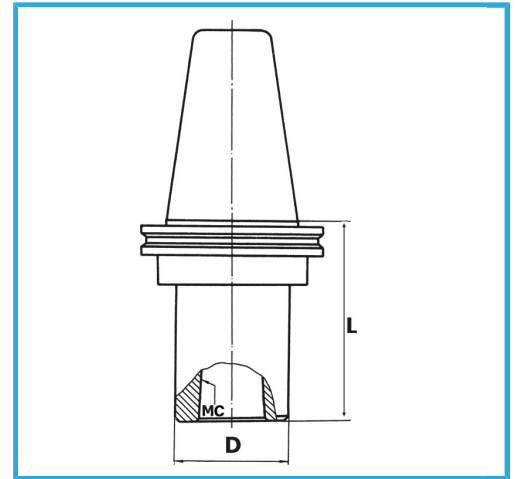

ISO	40
CM	3
D	40 mm
L	75 mm
Bruttogewicht	1,23 kg
EAN-Code	8012667007928



Box



Korrigiert



18Ni
CrMo5

-