

DIN 69871/A, AUSGEWUCHTETES SPANNFUTTERGEHÄUSE.
AUSWUCHTDREHZAHL 12.000 RPM.

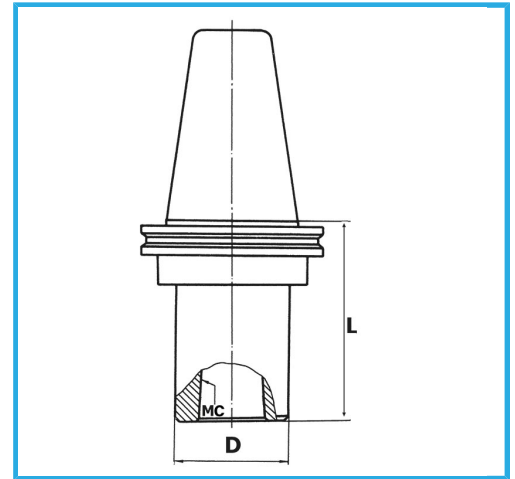

ISO	50
CM	3
D	40 mm
L	50 mm
Bruttogewicht	3,12 kg
EAN-Code	8012667008000



Box



Korrigiert



18Ni
CrMo5

-