

DIN 69871/A, AUSGEWUCHTETES SPANNFUTTERGEHÄUSE.
AUSWUCHTDREHZAHL 12.000 RPM.

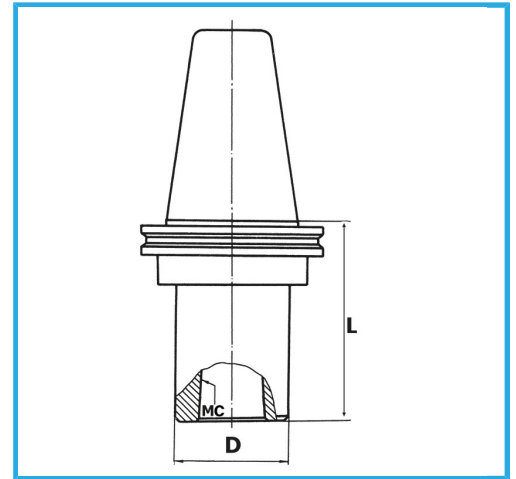

ISO	50
CM	4
D	50 mm
L	80 mm
Bruttogewicht	3,55 kg
EAN-Code	8012667008017



Box



Korrigiert



18Ni
CrMo5

-