

DIN 69871/A, AUSGEWUCHTETES SPANNFUTTERGEHÄUSE.
AUSWUCHTDREHZAHL 12.000 RPM.

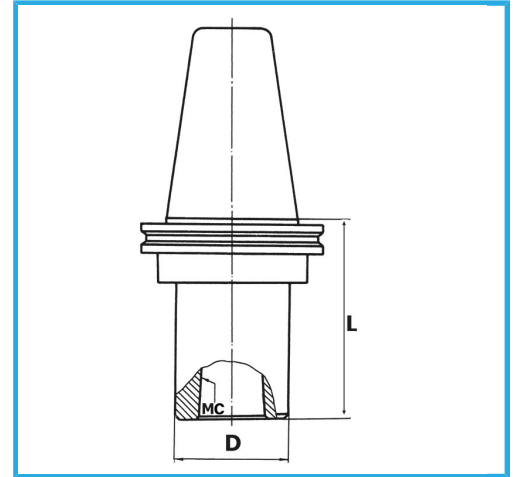

ISO	50
CM	5
D	63 mm
L	110 mm
Bruttogewicht	3,56 kg
EAN-Code	8012667008024



Box



Korrigiert

18Ni
CrMo5

-