

MAS-403 BT, AUSGEWUCHTETES SPANNFUTTERGEHÄUSE, MIT
ABSAUGSCHLITZ FÜR WERKZEUGE. AUSWUCHTDREHZAHL 12.000
RPM.

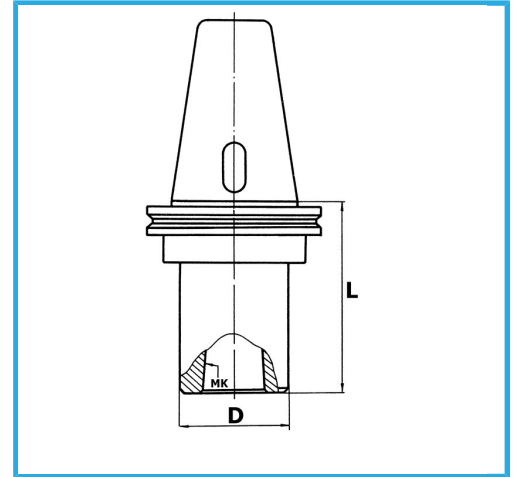

BT	40
CM	1
D	25 mm
L	45 mm
Bruttogewicht	1,10 kg
EAN-Code	8012667008376



Box



Korrigiert



18Ni
CrMo5

-