

MAS-403 BT, AUSGEWUCHTETES SPANNFUTTERGEHÄUSE, MIT
ABSAUGSCHLITZ FÜR WERKZEUGE. AUSWUCHTDREHZAHL 12.000
RPM.

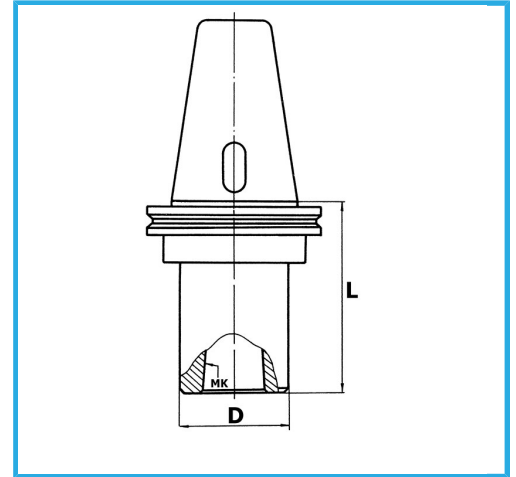

BT	40
CM	2
D	32 mm
L	60 mm
Bruttogewicht	1,16 kg
EAN-Code	8012667008383



Box



Korrigiert



18Ni
CrMo5

-