

MAS-403 BT, AUSGEWUCHTETES SPANNFUTTERGEHÄUSE, MIT
ABSAUGSCHLITZ FÜR WERKZEUGE. AUSWUCHTDREHZAHL 12.000
RPM.

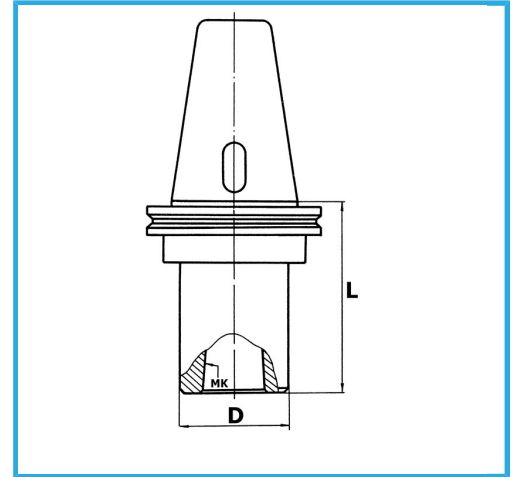

BT	50
CM	2
D	32 mm
L	40 mm
Bruttogewicht	3,59 kg
EAN-Code	8012667008413



Box



Korrigiert



18Ni
CrMo5

-