

MAS-403 BT, CORPO MANDRINO BILANCIATO, CON ASOLA DI ESTRAZIONE PER UTENSILI. EQUILIBRATURA 12.000 RPM.

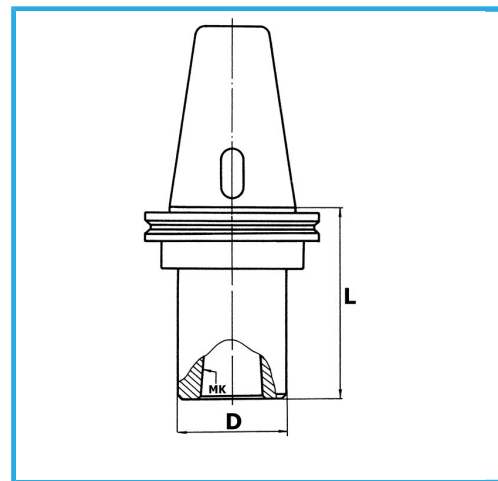

€154,00



BT	50
CM	2
D	32 mm
L	40 mm
Peso lordo	3,59 kg
Codice EAN	8012667008413



Scatola



Rettificato

18Ni  
CrMo5