

MAS-403 BT, AUSGEWUCHTETES SPANNFUTTERGEHÄUSE, MIT
ABSAUGSCHLITZ FÜR WERKZEUGE. AUSWUCHTDREHZAHL 12.000
RPM.

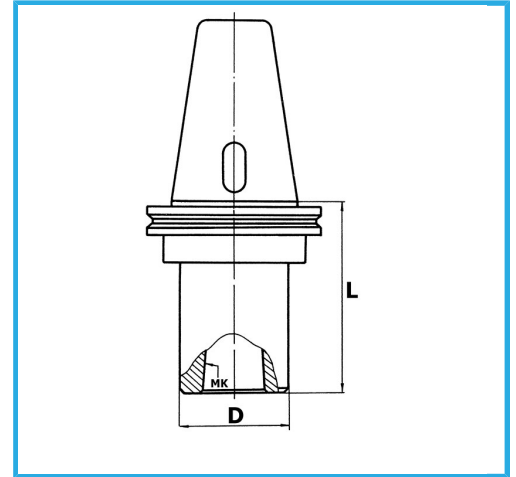

BT	40
CM	3
D	40 mm
L	75 mm
Bruttogewicht	1,24 kg
EAN-Code	8012667008390



Box



Korrigiert



18Ni
CrMo5

-