

MAS-403 BT, CORPO MANDRINO BILANCIATO, CON ASOLA DI ESTRAZIONE PER UTENSILI. EQUILIBRATURA 12.000 RPM.

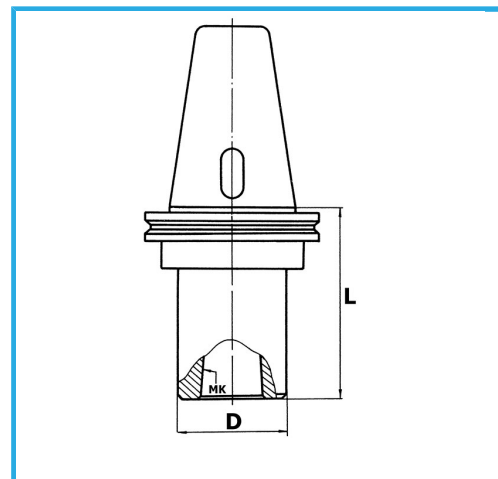

€149,00



BT	40
CM	3
D	40 mm
L	75 mm
Peso lordo	1,24 kg
Codice EAN	8012667008390



Scatola



Rettificato

18Ni
CrMo5