

MAS-403 BT, CORPO MANDRINO BILANCIATO, CON ASOLA DI ESTRAZIONE PER UTENSILI. EQUILIBRATURA 12.000 RPM.

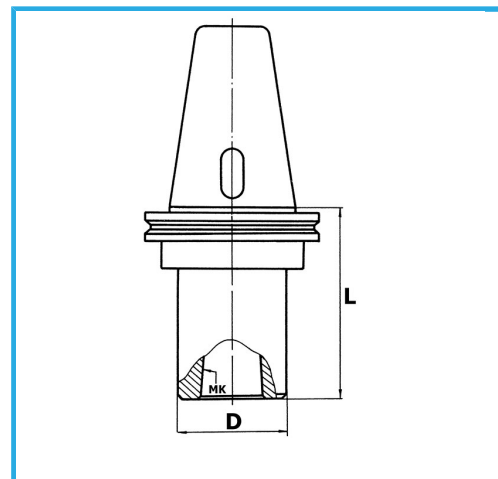

€154,00



BT	50
CM	3
D	40 mm
L	75 mm
Peso lordo	3,77 kg
Codice EAN	8012667008420



Scatola



Rettificato



18Ni
CrMo5