

MAS-403 BT, AUSGEWUCHTETES SPANNFUTTERGEHÄUSE, MIT
ABSAUGSCHLITZ FÜR WERKZEUGE. AUSWUCHTDREHZAHL 12.000
RPM.

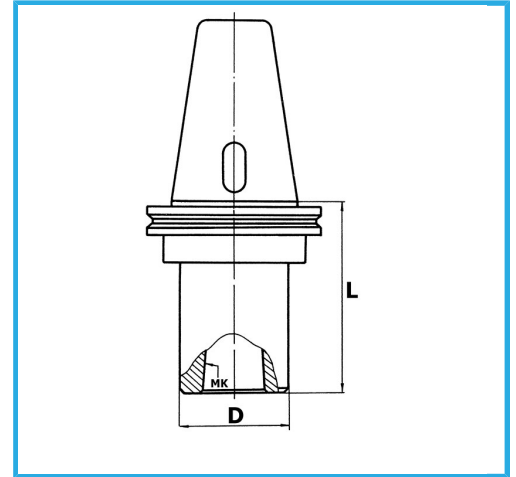

BT	40
CM	4
D	50 mm
L	98 mm
Bruttogewicht	1,56 kg
EAN-Code	8012667008406



Box



Korrigiert



18Ni
CrMo5

-