

MAS-403 BT, AUSGEWUCHTETES SPANNFUTTERGEHÄUSE, MIT
ABSAUGSCHLITZ FÜR WERKZEUGE. AUSWUCHTDREHZAHL 12.000
RPM.

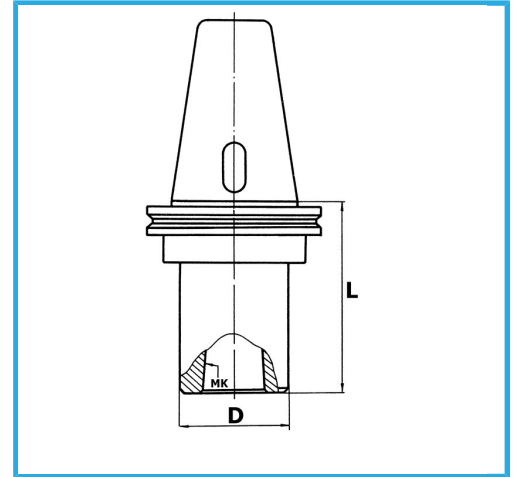

BT	50
CM	4
D	50 mm
L	80 mm
Bruttogewicht	3,80 kg
EAN-Code	8012667008437



Box



Korrigiert



18Ni
CrMo5

-