

MAS-403 BT, CORPO MANDRINO BILANCIATO, CON ASOLA DI ESTRAZIONE PER UTENSILI. EQUILIBRATURA 12.000 RPM.

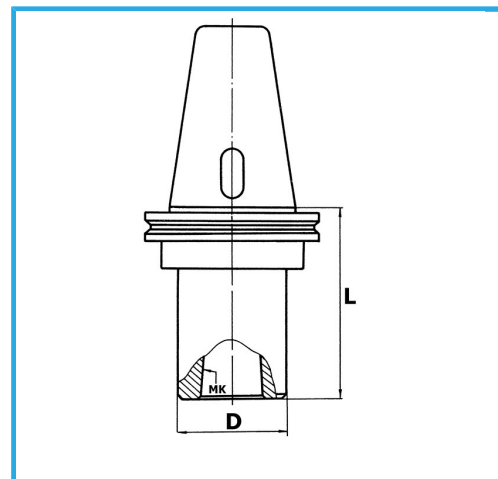

€171,00



BT	50
CM	4
D	50 mm
L	80 mm
Peso lordo	3,80 kg
Codice EAN	8012667008437



Scatola



Rettificato

18Ni
CrMo5