

MAS-403 BT, CORPO MANDRINO BILANCIATO, CON ASOLA DI ESTRAZIONE PER UTENSILI. EQUILIBRATURA 12.000 RPM.

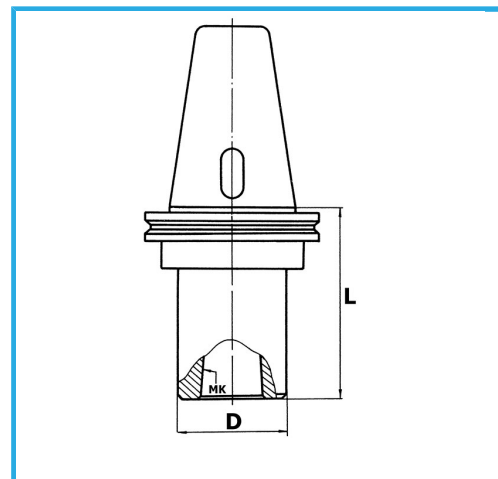

€202,00



BT	50
CM	5
D	63 mm
L	110 mm
Peso lordo	4,07 kg
Codice EAN	8012667008444



Scatola



Rettificato

18Ni  
CrMo5