

MAS-403 BT, CORPO MANDRINO BILANCIATO. EQUILIBRATURA 12.000 RPM.

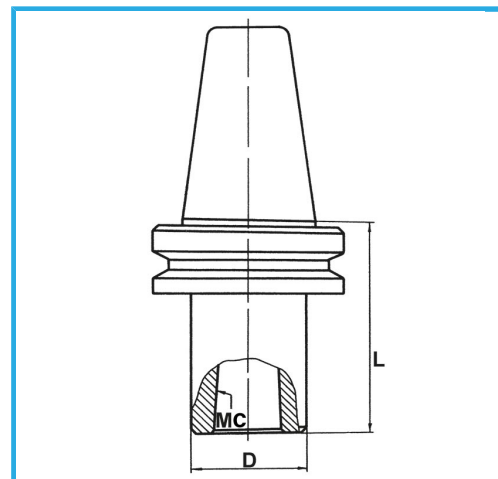

€127,00



BT	40
CM	1
D	25 mm
L	45 mm
Peso lordo	1,14 kg
Codice EAN	8012667008451



Scatola



Rettificato

18Ni  
CrMo5