

MAS-403 BT, CORPO MANDRINO BILANCIATO. EQUILIBRATURA 12.000 RPM.

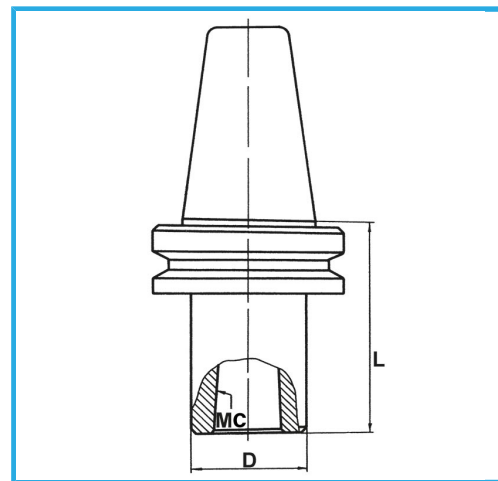

€127,00



BT	40
CM	2
D	32 mm
L	60 mm
Peso lordo	1,23 kg
Codice EAN	8012667008468



Scatola



Rettificato

18Ni
CrMo5