

MAS-403 BT, CORPO MANDRINO BILANCIATO. EQUILIBRATURA 12.000 RPM.

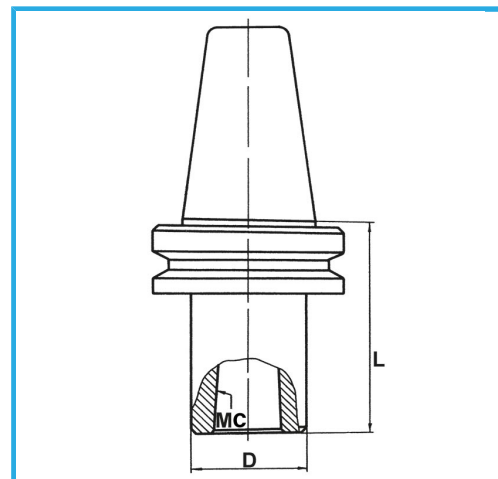

€169,00



BT	50
CM	2
D	32 mm
L	40 mm
Peso lordo	3,68 kg
Codice EAN	8012667008499



Scatola



Rettificato

18Ni
CrMo5