

MAS-403 BT, CORPO MANDRINO BILANCIATO. EQUILIBRATURA 12.000 RPM.

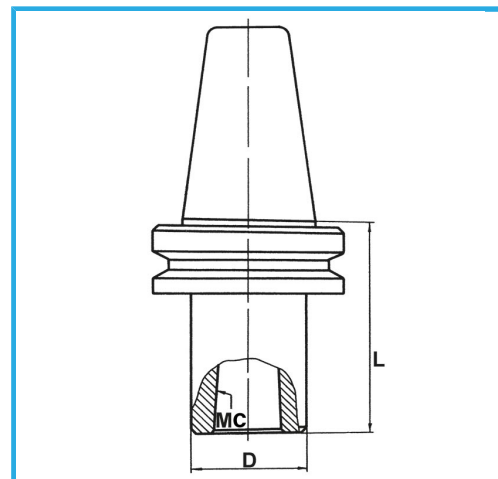

€196,00



BT	50
CM	4
D	50 mm
L	80 mm
Peso lordo	3,97 kg
Codice EAN	8012667008512



Scatola



Rettificato

18Ni
CrMo5