

MAS-403 BT, CORPO MANDRINO BILANCIATO, PER FRESE (WELDON)
SECONDO NORMA DIN 1835 B E DIN 6535 HB. FORNITO CON VITE DI
SERRAGGIO...

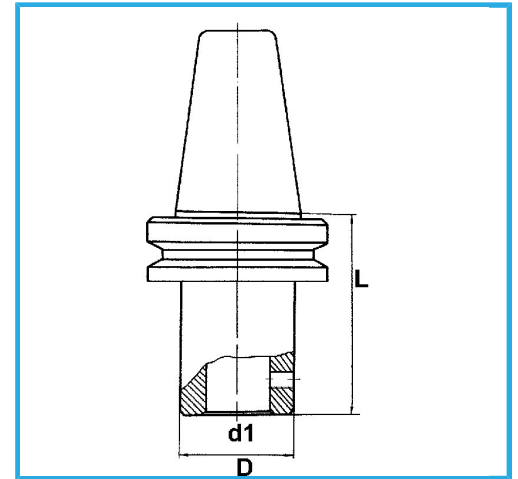

€138,00



BT	50
d1 - h6	6 mm
D	25 mm
L	65 mm
Peso lordo	3,66 kg
Codice EAN	8012667193058



Scatola



Rettificato

18Ni
CrMo5