

MAS-403 BT, AUSGEWUCHTETES SPANNFUTTERGEHÄUSE, FÜR  
FRÄSER (WELDON) NACH DIN 1835 B UND DIN 6535 HB. LIEFERUNG  
MIT..

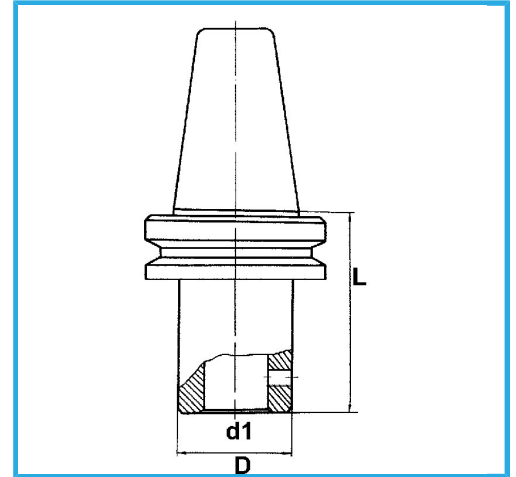

BT	40
d1 - h6	8 mm
D	28 mm
L	60 mm
Bruttogewicht	1,12 kg
EAN-Code	8012667195885



Box



Korrigiert



18Ni  
CrMo5

-